

THIS DOCUMENT IS THE PROPERTY OF KEYSTONE ELECTRONICS CORP. AND SHALL NOT BE REPRODUCED, DISTRIBUTED OR USED AS A BASIS FOR MANUFACTURE WITHOUT PRIOR WRITTEN PERMISSION FROM KEYSTONE ELECTRONICS CORP.

MOUNTING DETAIL

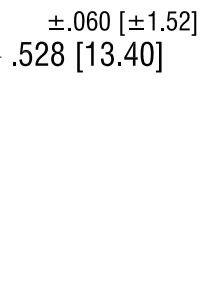
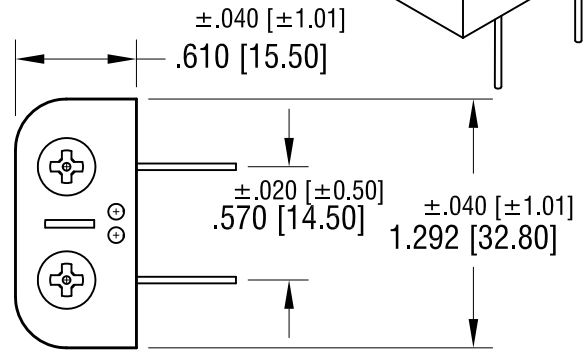
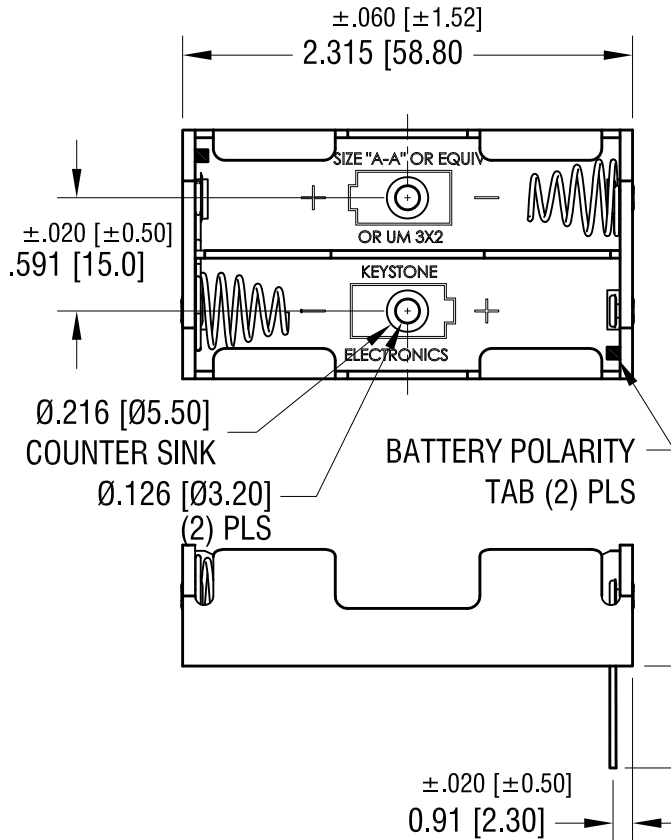
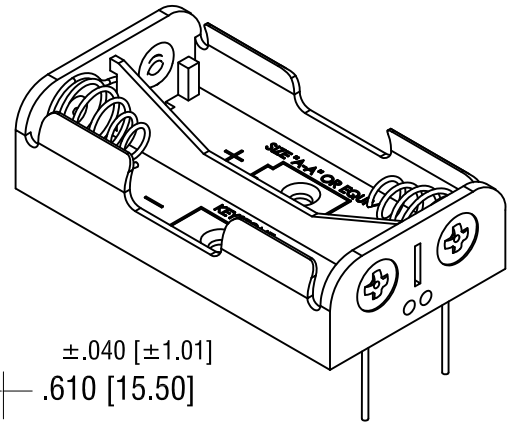
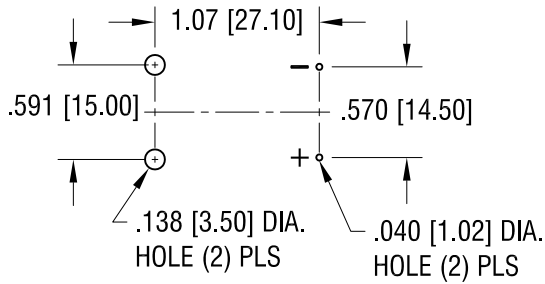

NOTE:

- 1. HOLDER: MAT'L: POLYPROPYLENE
- SPRING: MAT'L: MUSIC WIRE, .025 [0.63] DIA.
- PC TERMINALS: MAT'L: BRASS, .032 [0.81] DIA.

6.29.21	CHANGE AS PER ECN 21-060	K
12.28.20	CHANGE AS PER ECN 12-100	H
7.24.12	CHANGE AS PER ECN 12-094	G
11.10.11	CHANGE AS PER ECN 11-153	F
6.12.09	CHANGE AS PER ECN 09-066	E
5.02.06	CHANGE AS PER ECN 06-025	D
DATE	DESCRIPTION	REV.

KEYSTONE ELECTRONICS CORP.			
www.keyelco.com • NEW HYDE PARK, NY 11040 • Tel (516) 328-7500			
PART NAME		PC BATTERY HOLDER (2) 'AA'	
MATERIAL		AS NOTED	
FINISH		DRN BY	DATE
NICKEL PLATE		BOONE	10.11.95
		APP'D	SCALE
TOLERANCES INCH [MM]		CODE	DWG NO.
ANGULAR ± 1°		C	2462
UNLESS OTHERWISE SPECIFIED			