

THIS DOCUMENT IS THE PROPERTY OF
KEYSTONE ELECTRONICS CORP. AND
SHALL NOT BE REPRODUCED, DISTRIBUTED
OR USED AS A BASIS FOR MANUFACTURE
WITHOUT PRIOR WRITTEN PERMISSION
FROM KEYSTONE ELECTRONICS CORP.

ACTUAL SIZE

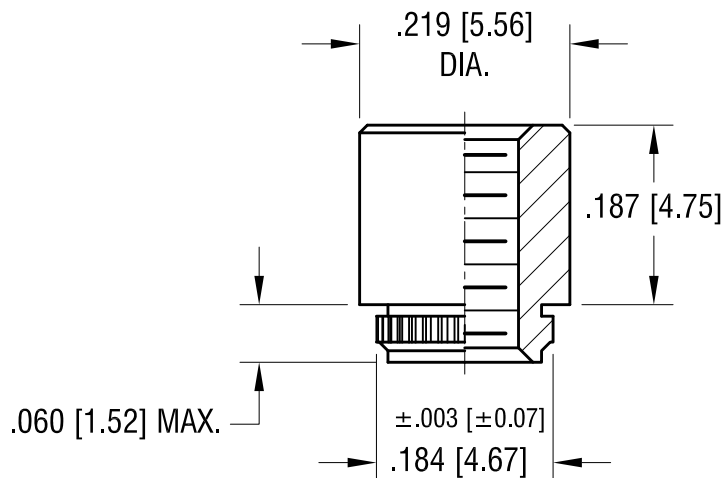
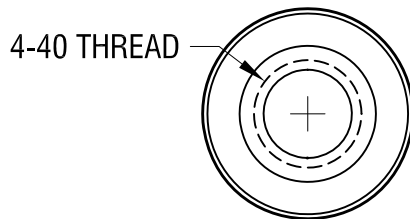

KEYSTONE ELECTRONICS CORP.

www.keyelco.com • NEW HYDE PARK, NY 11040 • Tel (516) 328-7500

PART NAME

FORCE-FIT STANDOFF, THREADED

MATERIAL

STAINLESS STEEL

FINISH

NONE

DRN BY

NT

DATE

11.15.18

APP'D

LN

SCALE

5X

TOLERANCES

INCH [MM]

DECIMAL ± .005 [± 0.13]

ANGULAR ± 1°

UNLESS OTHERWISE SPECIFIED

CODE

C

DWG NO.

4718

DATE	DESCRIPTION	REV.